

# Quilting with the Grace Frame™

## Contents

Parts Lists	3
Care of your Grace Frame	2
Assembly	5
Leg and end assembly	5
Brace Assembly	6
Pole assembly	8
Cog wheel assembly	8
Assembly of accessories	
4'h pole kit attachment	10
Super King extension assembly	
Brace	6
Pole	8
Edge Master™ application	16
Folding the Grace Frame	11
Making and using cloth leaders	17
Quilting instructions	12
Trouble shooting	15
Warranty information	2
Addresses and phone numbers	2

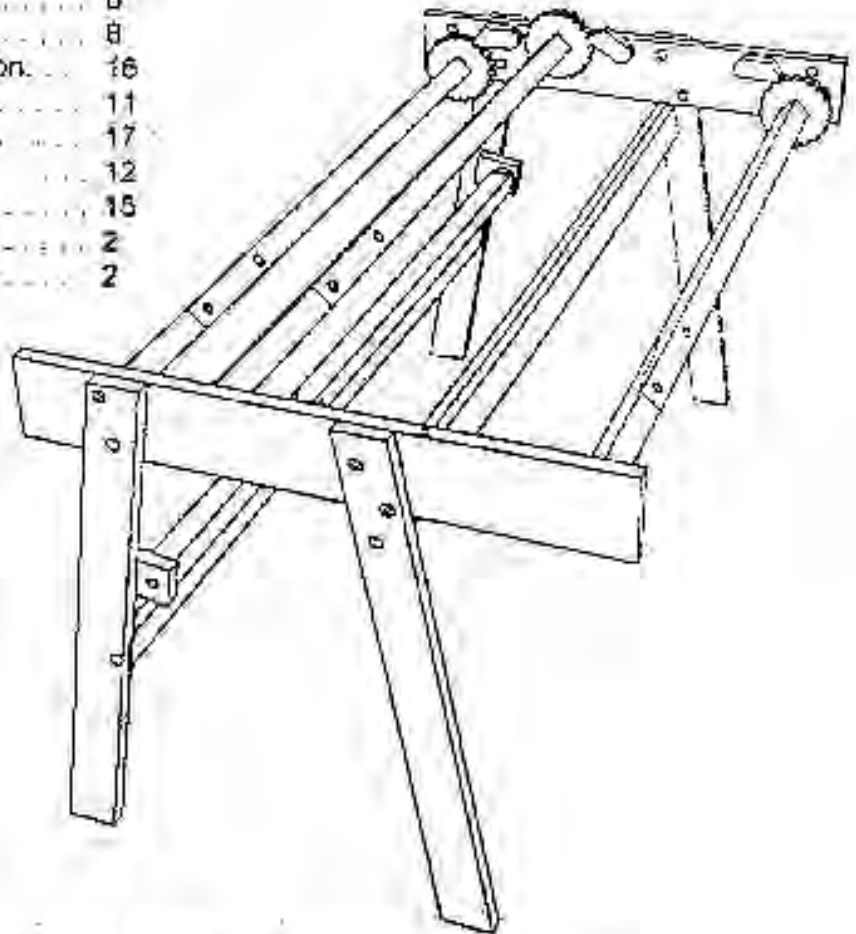

THE  
Grace  
Company

Copyright May 1993 Jim M. Bagley, The Grace Company

Reproduction Prohibited.

## Care of Your Grace Frame

The frame may be sealed and/or stained with an application of tung oil which will help preserve the wood and will help to prevent warping. Test stain on an inconspicuous place.

Many different finishes and/or stains may be suitable for sealing and beautifying your Grace Frame™. You may want to consult your local paint retailer for finishes which will apply easily and dry hard not oily.

### Tips

- Store frame in a dry place- preferably with poles and braces in vertical position if not assembled.
- Do not carry the frame by the quilting poles.
- Do not drop the frame or let it twist out of square.

## Grace Frame Lifetime Limited Warranty

We will replace any part that fails to work for any reason other than loss or intentional damage by the purchaser. This simply means that "if it breaks, then we will fix it." We will even pay the freight if it is our fault and if the problem is made known to us within one year after the purchase date. After one year we will replace any part for as long as we are in business (Forever We Hope). We will repair or replace any defective part free of charge during the one year warranty period. After the warranty period has expired we will replace any part for the cost of shipping and handling of that part. Any broken or damaged part must be sent postage prepaid to the Grace Company before replacement can be made.

For correspondence concerning your Grace Frame™, write to:

**The Grace Company  
P.O. Box 27823  
Salt Lake City, UT 84127**

For shipping of materials to the Grace Company address package (postage prepaid) to:

**The Grace Company  
801 West Layton Avenue  
Salt Lake City, UT 84104**

For technical support, call (801) 972-5801. All calls will be returned.

### About the Grace Quilting Frame

The Grace Quilting System has been developed over the past decade with several original design innovations. Due to feedback from many of the thousands of quilters who have purchased and do use the Grace Frame™ we have been able to make a frame that will really enhance the entire process of hand quilting from beginning to end. If you have any suggestions that will help us to improve our product or service, please write to The Grace Company.

Thank You and Happy Quilting

# Grace Frame Parts List

## Hardware

### Quantity

12

3

12

4

24

4

6

### Description

1/4" X 1- 1/2" hex-head bolt (smallest bolt)

1/4" X 2" hex-head bolt (longest 1/4" bolt)

5/16" X 1-1/2" hex-head bolt (fattest bolt)

Large 5/16" flat washers

Small 1/4" flat washers

Wing-nuts 5/16"

Plastic 2" washers

## Wood Parts

### Quantity

1

### Part Number

LE5-34 or LE5-28

### Description

Left End Board for 34" or 28" frame profile. Both are not included

Part LE5-34

TOP



FRONT

Part LE5-28

TOP

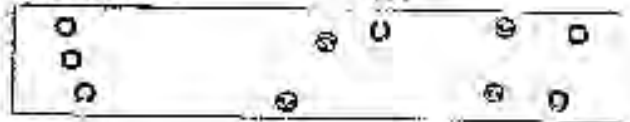

FRONT

1

RE5-34 or RE5-28

Right End Board for 34" or 28" frame profile. Both are not included.

Part RE5-34

TOP

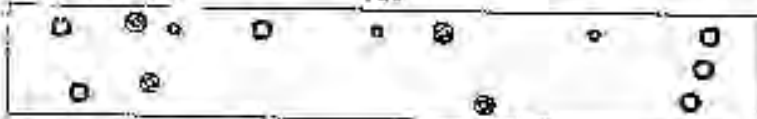

FRONT

Part RE5-28

TOP

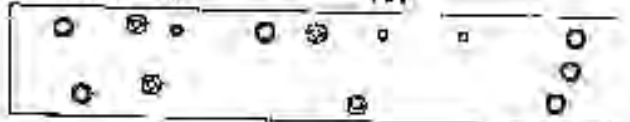

1

1

1

1

LR33-3

LF33-3

RR33-3

RF33-3

Right Front Leg

Left Front Leg

Right Rear Leg

Left Rear Leg

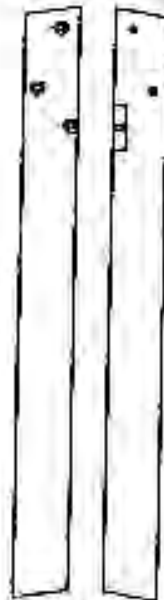

Part LR33-3



Part LF33-3



Part RR33-3

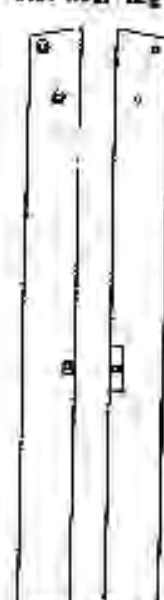

Part LR33-3

Quantity  
4

Part Number  
BR61-25

Description  
Brace (reversible and telescoping)

BR61-25

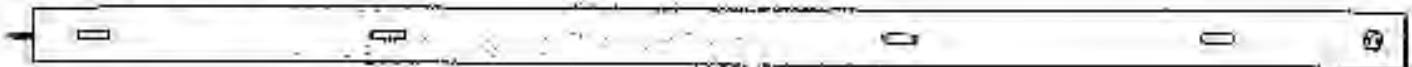

3

PL48-5

Spring-end pole **D**

**D**

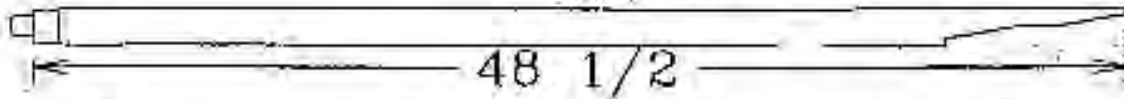

3

PL19-5

Small Pole extension **E**

**E**

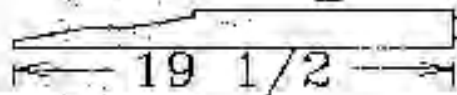

3

PL55-5

Large Pole extension **F**

**F**

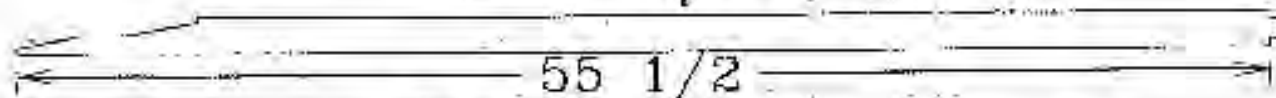

3

PL22-0

Double end extension **G**

**G**

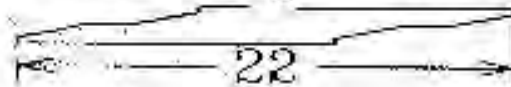

3

WH5-7B

Cog or Ratchet Wheel

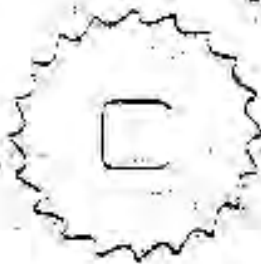

3

STP15

Cog Stop or Pawl



Super King Parts List (optional- sold separately)

3

PL22-0

Double end extension **G**

2

BR14-0

**BR14-0**

Double end Brace Extension



6

1/4" X 1-1/2"

Hex head bolts

6

1/4"

Flat Washer

4

5/16" X 1-1/2"

Hex head bolts

4

5/16"

Flat Washer

# ASSEMBLY OF QUILTING FRAME

## Unpacking

Using the parts list as a reference, take all of the parts out of the box and make sure that you have all the parts. If there is something missing or broken, contact The Grace Company. We will promptly ship any needed item.

## TOOLS

To assemble the Grace Frame you will need a few common tools. Once the frame is assembled no tools will be needed for the utilization of the frame.

Make sure that these tools are clean and free of grease.

1. One ratchet driver with one 1/2" socket and one 7/16" socket.
2. One Phillips #2 screwdriver (if installing the 4th pole kit)
3. One pair of slip joint pliers

## Section 1. Leg to End Assembly

- Parts needed:
- 1 each LE5-34 End (or LE5-28 for narrow profile)
  - 1 each RE5-34 End (or RE5-28 for narrow profile)
  - 1 each RF33-3, LF33-3, RR33-3, LR 33-3 (Legs)
  - 8 each 5/16" X 1-1/2" hex head bolts
  - 8 each 1/4" flat washers (smaller washer)

### Left End

#### Step 1.

Start with part LE5-34 (or LE5-28)

Make sure you know which side is the top and which side is the front.  
(See picture)

Position part on floor with metal inserts facing the floor. The front of the part should be to your right and the top edge (with lamp hole) should be facing away from you.

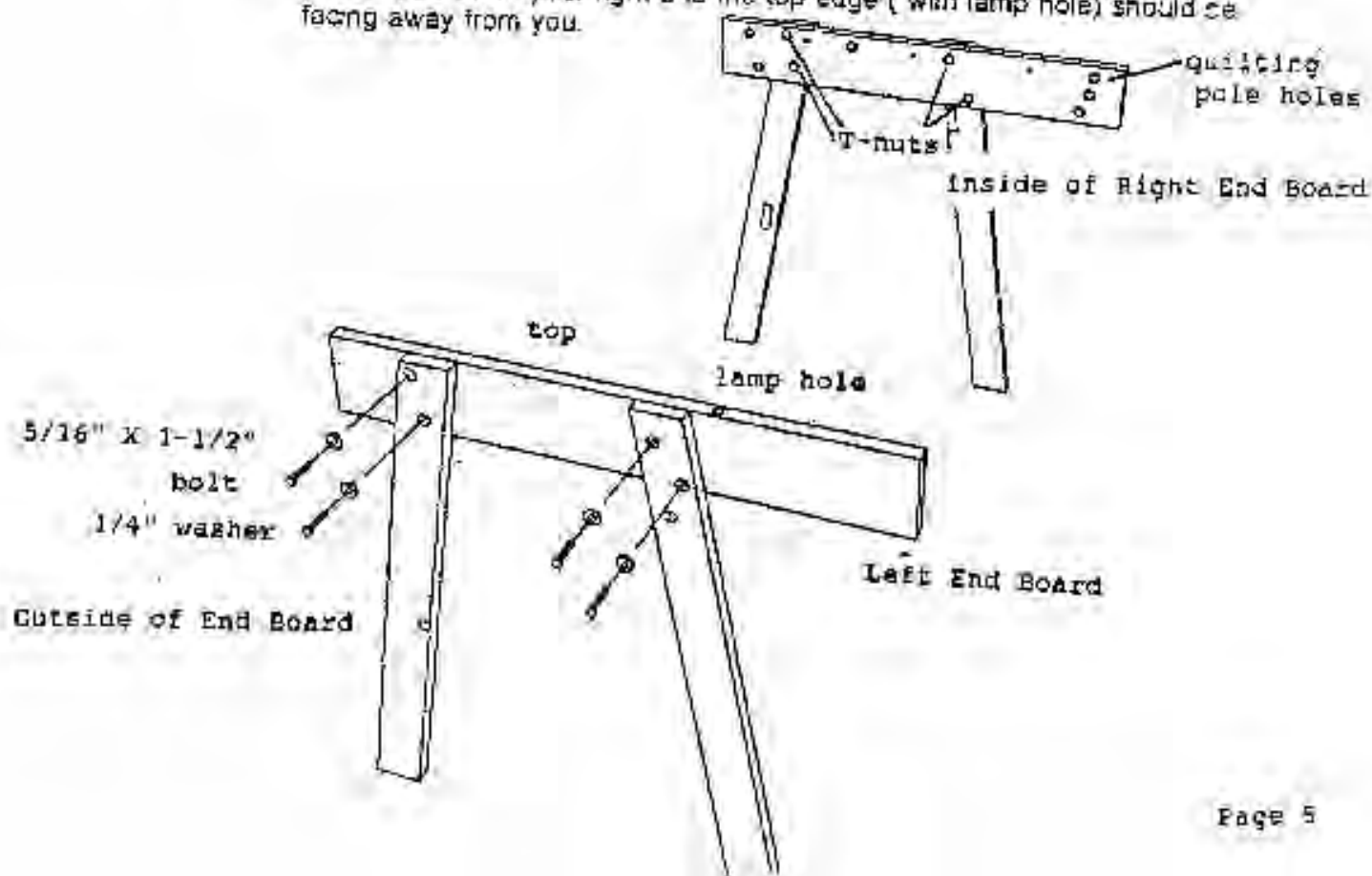

**Step 2.**

Take the leg parts LF33-3 and LR33-3 and position them so holes match up over holes in End Board as shown in drawing.  
Insert 5/16" bolts through 1/4" washers

**Step 3.**

By hand, start each bolt through each Leg hole and continuing through End Board hole into the T-nut

Make sure all four bolts have been started into the threads of the T-nut before tightening with the 1/2" socket wrench

**Right End**

Repeat these steps for the right end with parts RE5-34 (or RE5-28 for narrow profile) using leg parts RF33-3 and RR33-3

Part RE5-34 should be placed on the floor with the metal inserts facing the floor and the front to your left

**\*Tip--** Legs will not fit if you try to put them in the wrong place.

**Section 2. Brace Assembly**

Parts needed: 2 each part BR61-25 Braces

4 each 5/16" x 1-1/2" Hex Head Bolt

4 each 5/16" (Larger) Flat Washer

\* If Super King Extension Is Used

2 each part BR14-0 Double End Brace Extension

4 each 5/16" x 1-1/2" Hex Head Bolt

4 each 5/16" (larger) Flat Washer

Decide which size quilt frame you will need to put up. (See sizes in drawing)

crib Size - 58" Quilting Space BR61-25

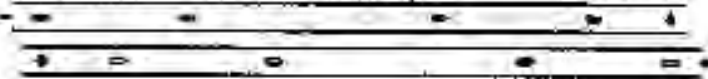

Twin Size - 72" Quilting Space

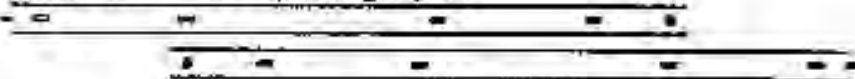

Queen Size - 94" Quilting Space

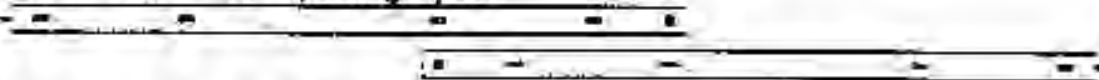

King Size - 108" Quilting Space



Super King Size\* - 122" Quilting Space

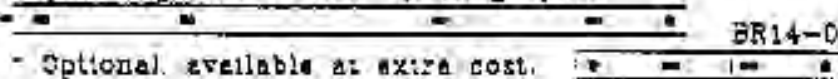

\* Optional, available at extra cost.



### Step 1.

Select any two of part BR61-25 and place them side by side with hanger bolts in each part pointing in opposite directions and the metal T-nut inserts facing outside.

### Step 2.

Slide the two parts against each other in a telescoping fashion until the T-nut hole lines up with the desired slot for the size frame that you need to set up.

\*Tip-- The overall length of the brace will be about 4-1/2" inches larger than the quilting space.

### Step 3.

Put the large washer on the 5/16" X 1-1/2" bolt and start through the slot first, and continuing through the round hole and into the metal T-nut..\*

\*Tip-- Do not tighten bolts at this time (the braces will be adjusted later in the assembly process as instructed)

Repeat these above steps with the other two brace parts BR61-25

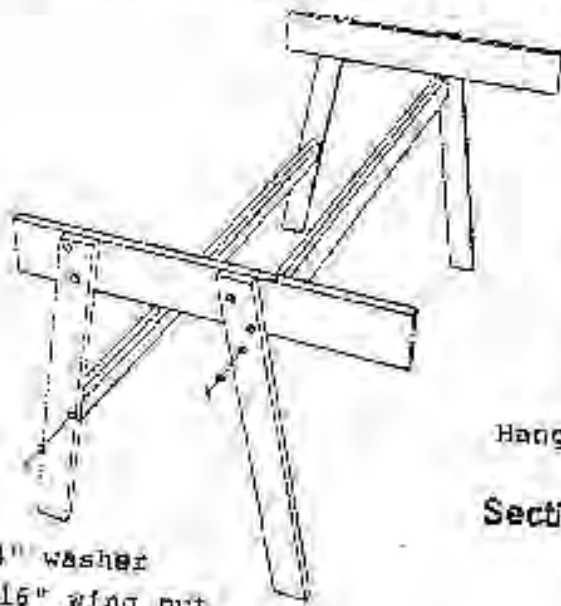

1/4" washer  
5/16" wing nut

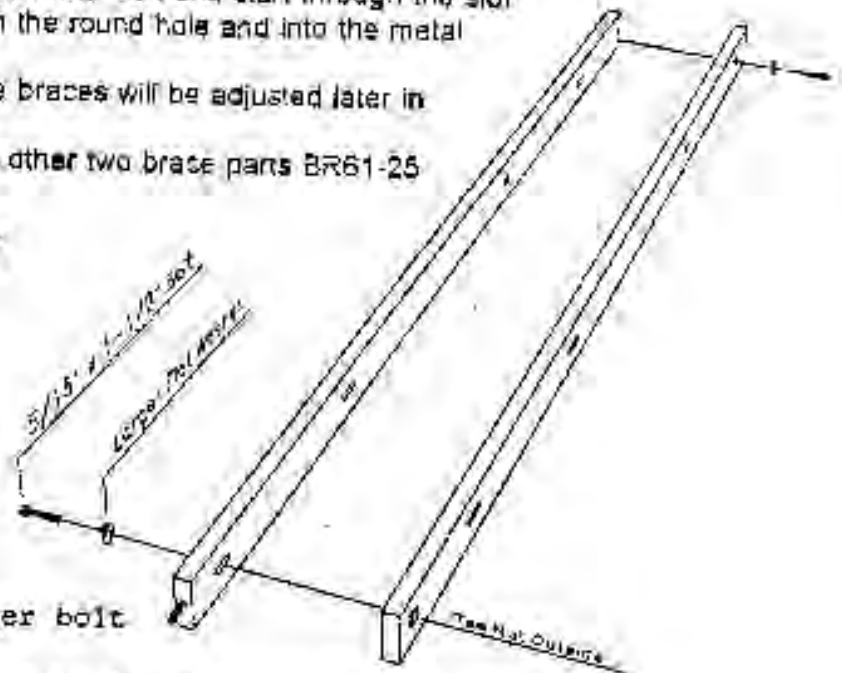

Hanger bolt

T-nut Outside

### **Section 3. Brace to Leg Assembly**

Parts needed: 4 1/4" (smaller) Washer

4 Wing Nuts

Left end Right End assembled with Legs

Both assembled Braces

### Step 1

Place the end of the 5/16" Hanger Bolts that are inserted in the ends of the Braces into the holes in the 3/4" x 2-1/2" slots which are located on the inside of the front Legs.

### Step 2

Place a 1/4" (smaller) Flat Washer over the end of the Hanger Bolt. Turn the 5/16" Wing Nut onto the end of the Hanger Bolt. Tighten Wing Nut until the joint is solid (pliers may be needed to tighten the Wing Nut, however finger tight may be good enough).

\*Tip-- Very Important-- Please note that the ends of the assembled brace are offset from each other by 3/4". Also, the 1/4" deep slots in the legs are offset by 3/4". If the braces are attached to the leg backward or up-side-down, then the End Boards will not align with each other. To check the alignment after installing the first Brace simply stand at one end of the frame and sight down to the other. Any misalignment will be very noticeable. If the ends are off by 1-1/2", then turn the brace over from bottom to top (not end-for-end). Check the alignment and install the second brace to the rear legs.

## Section 4. Quilting Pole Assembly

Parts needed: PL48-5 D  
PL19-5 E  
PL55-5 F  
PL22-0 G  
1/4" X 1-1/2" hex head bolts  
1/4" flat washers (small)

### Step 1

Before beginning assembly of quilting poles, determine which size of the frame you are putting up and using the following diagram select the correct parts in order to assemble three pole units.

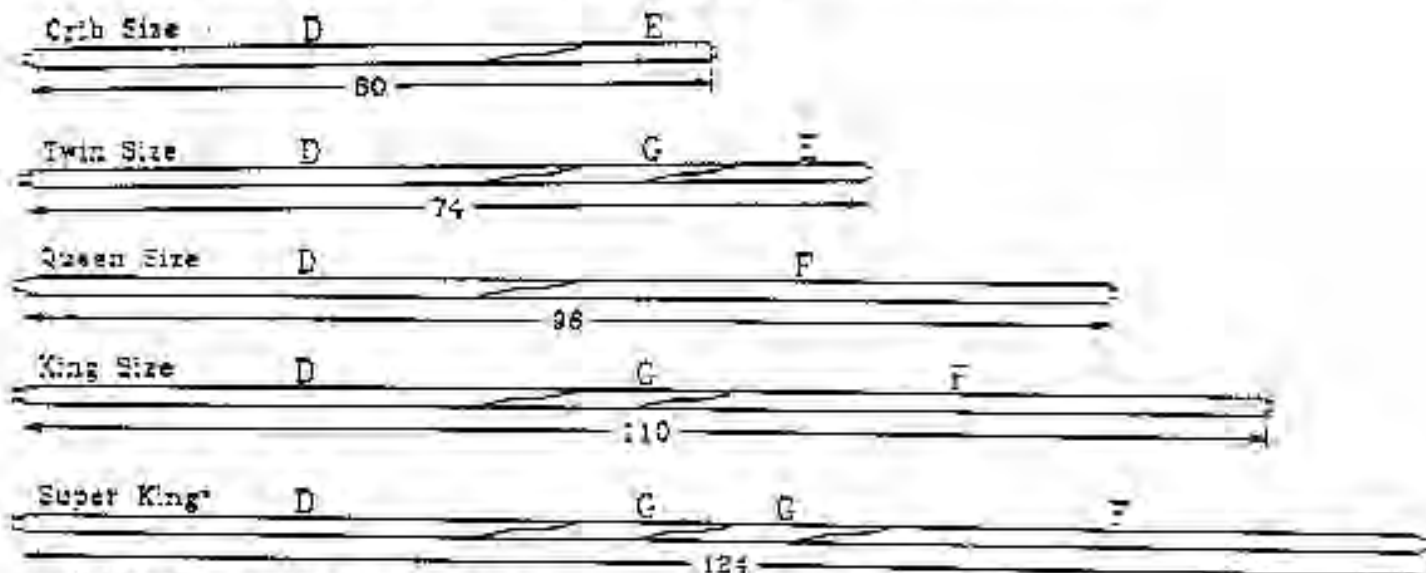

\* Optional available at extra cost.

### Step 2

Align the slanted ends of the pole parts together and insert each 1/4" X 1-1/4" bolt through a small flat washer and into the round hole in the wood and continuing into the metal T-nut. Begin all the bolts, then tightly holding the wood pole together align it squarely on all sides. Now use the socket to completely tighten all bolts.

Continue bolting together all slanted ends of poles until you have three quilting poles completed.

## Section 5 Quilting Pole to End Assembly

\*Tip-- Keep these positions of the cog wheel as illustrated below in mind while assembling the Quilting Poles to the Ends.

Parts needed: 3 assembled Quilting Poles  
6 Plastic washers  
1/2" socket wrench  
7/16" socket wrench  
3 cog wheels WH5-78  
3 cog stops STP15  
3 1/4" X 2" hex head bolts

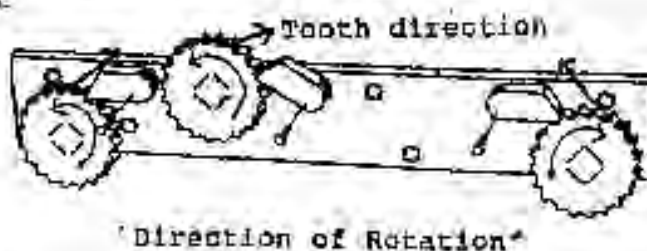



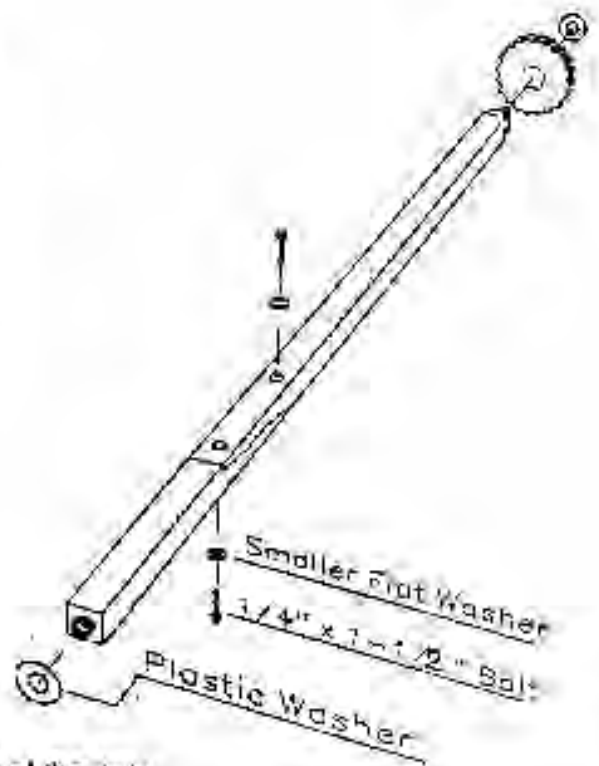
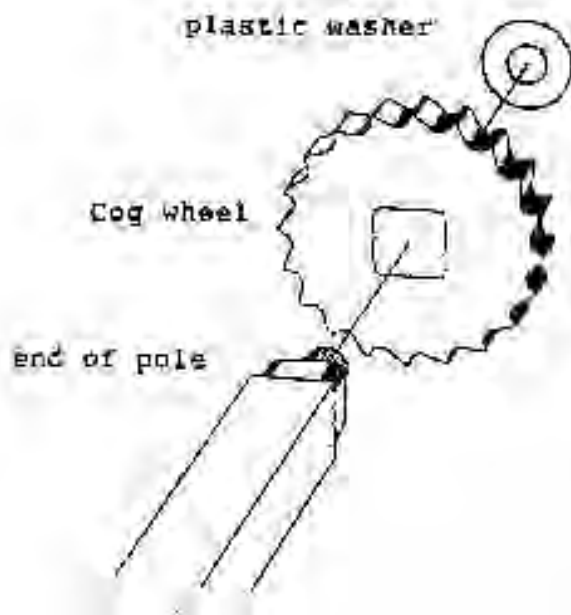

**Step 1**

Slip the cog wheel onto the quilting pole.  
Slip one of the plastic washers onto both ends of the pole.  
Stand facing the front of the frame.

**Step 2**

Position the Quilting Pole end (the end that does not have the cog wheel on it) into the left front hole in the left end board.

**Step 3**

Depress the spring loaded pole end on the opposite end of the pole and slip that end into the pole hole on the right end.

**Tip--**You can adjust the frame longer or shorter if you have not tightened the bolts in the braces.

**Step 4**

Adjust the brace slots until the frame poles will roll freely but will have no space between the end of the poles and the End boards.  
Tighten the brace bolts with 1/2" socket wrench.

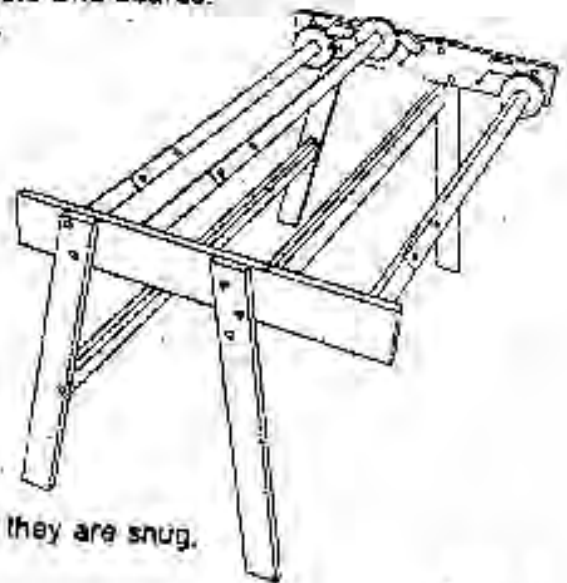

**Step 5**

Install the cog stops or pawls with 1/4" X 2" bolts

**Tip--** Tighten bolt into the 1/4" wood insert in the Right End until they are snug.  
Do not overtighten this bolt.

## Section 6. 4th Pole Kit Assembly (optional)

Parts needed: 1 D PL48-5

1 E PL19-5

1 F PL55-5

1 G PL22-0 (or 2 with optional Super King Extension)

2 Mounts 4MT25-35

4 1/4" X 1-1/4" hex head bolts (or 6 with Super King Extension)

4 smaller 1/4" flat washer (or 6 with Super King Extension)

4 wood screws 1-1/8" long

4 3/8" wood plug caps

Phillips screwdriver #2

1 Small nail

Part 4MT25-35

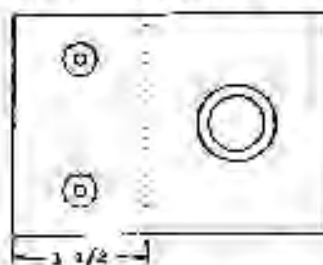

### Step 1.

The 4th Pole is attached to rear legs of the frame with two easily installed brackets.

Locate the brackets so that they are about 1-1/2" on the leg and 2" off.

The bottom of the brackets should be located about 3-1/4" above the back brace, as shown in the diagram below.

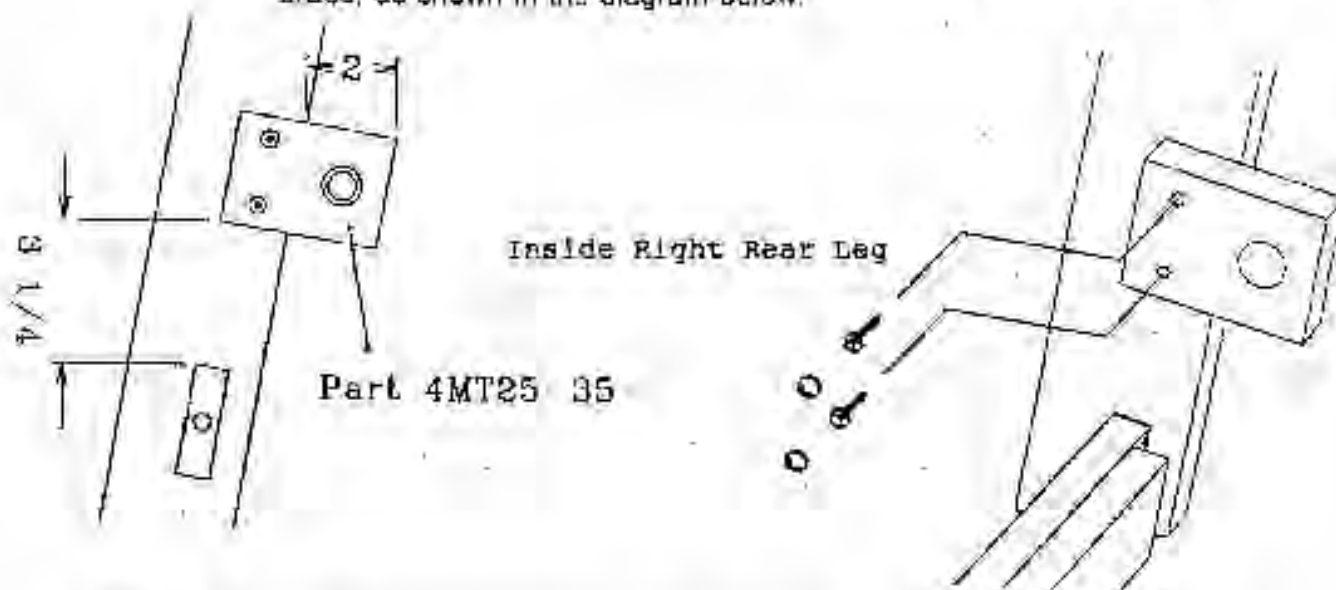

### Step 2.

Make a starter hole with a small nail before starting the screws. After you have lined up the bracket in the proper position, use the nail to make a mark on the leg so you will know where to make the starter holes.

### Step 3.

Begin the screws through the bracket and into the leg wood.

Completely tighten the screws.

Place the wooden buttons into the holes and tap them in place.

(You may use a drop of glue to permanently secure the buttons into place if desired.)

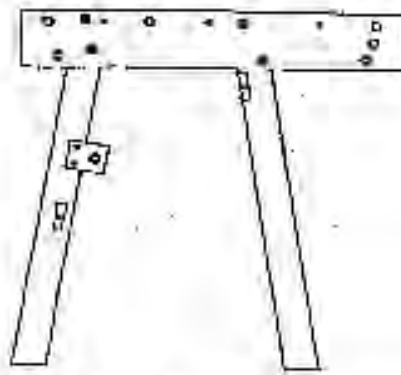

Inside Right View

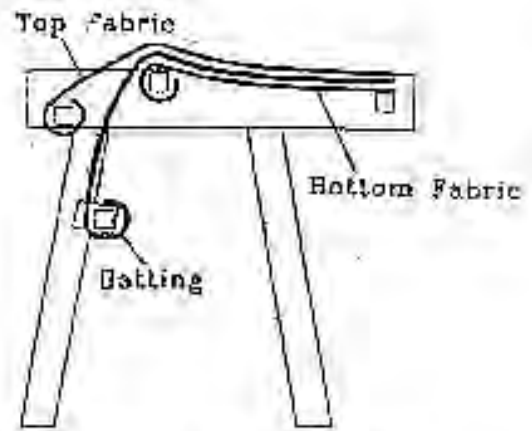

Batting Installed

**Section 7. Using the Fold Up Feature**

The fold-up feature of the frame is really impressive. It takes only about Two minutes for the quilter to fold up the frame into a package which will take only about 9" of floor space for the length of the quilt. The quilt can be left on the frame and it will remain taut while the frame is folded. You will probably need two people to accomplish this procedure easily with longer frames.

Step 1. Remove the top bolt from both front legs. Loosen the bottom bolt on both front legs.

Step 2. Fold the front legs forward 90°. Retighten the remaining bolts.

Step 3. Remove bottom bolts on both rear legs. Loosen top bolts on both rear legs.

Step 4. Rotate rear legs up and around 260°. Retighten remaining bolts (See diagram)

*\*Tip-* Do not loosen the wing nuts which are holding the braces to the right and left leg assemblies. This is very important. If the wing nuts are loosened, the frame will not be stable for folding or for unfolding.

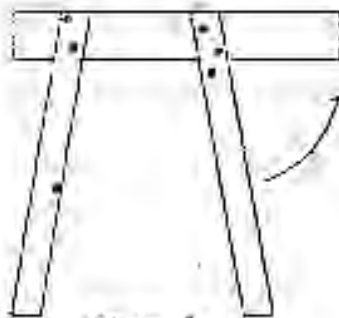

Step 1.

Remove top bolts  
Loosen bottom bolts

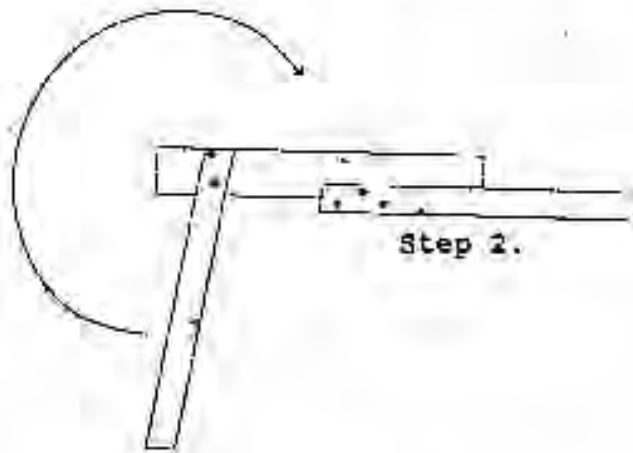

Step 3.

Remove bottom bolts  
Loosen top bolts



Step 4.

## HOW TO USE YOUR GRACE FRAME®

**GET READY:** Your quilt fabric may be tacked directly to the poles. However, using cloth leaders is a much better way to attach your quilt (see the cloth leader instruction sheet). Leaders are easy to make and allow the quilter to move the last few inches of the quilt forward from the rear pole to the front quilting area. If you choose to use leaders refer now to the instructions for making leaders and make them before proceeding to put a quilt on your frame.

Decide if you will be using the 4th pole kit (optional) for rolling the batting onto; if so, make sure the 4th pole kit is assembled and in place before using your frame.

**GET SET:** You will put the **BACKING** for the quilt on the frame first. I recommend the backing always be 2" to 4" larger than the top on all four sides, especially if your top is pieced rather than whole cloth. A pieced top will stretch out and be larger than the backing if you do not make this allowance.

If you use unseamed cloth for the backing, you may skip the following discussion. **Pieced Backs:** Cut off the selvages before you piece the back. The selvedge is woven tightly and won't have the same "give" as the fabric, causing the seam to be too tight. Use a slightly larger machine stitch than used in normal piecing when sewing the lengths to allow for a bit more "give" in the seam. Common back piecing is one seam down the middle or two seams down each side. If you have problems with lengthwise seaming being too tight try the optional crosswise piecing of the back or simply put the quilt on the frame crosswise.

**GO:** You will need large head, short shank tacks, tack hammer, tack lifter.

**BACK:** Fold the backing fabric in half and mark both top and bottom with a pin or pencil mark. Tack the center mark (inside of backing face up) to the center of the front pole. Lay the fabric naturally and evenly along the straight edge of the pole. Do not stretch the fabric. Tack the corners of the fabric to pole. Measure again to see if backing is centered equal distance from the outside edges of pole. We will finish tacking the front down after the back is attached to the middle pole. You need only a few tacks in it to hold it in place, and if you need to make adjustments you will have to remove only those few tacks.

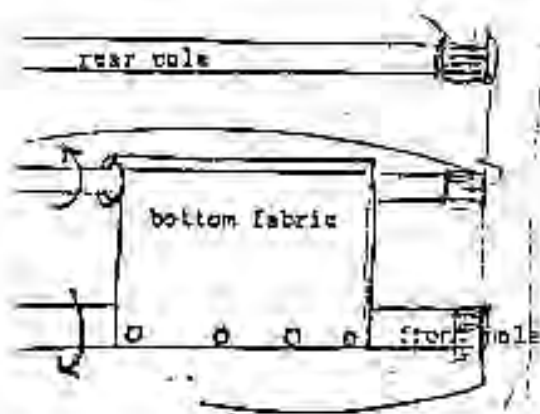
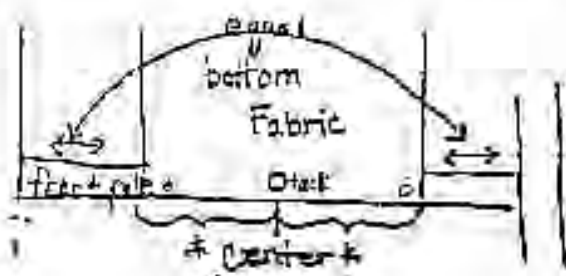

Tack the other end of the backing fabric to the middle quilting pole, centering with the mark as on the front pole. Tack the center and tack the corners, compare with front pole--the amount of pole wood showing beyond the edges of quilt should be equal on both sides. After you have it positioned, tack securely along the entire edge of the middle pole, using plenty of tacks.

Roll the material onto the middle pole, making a smooth roll. Be sure that no large wrinkles are present. I smooth the quilt from the center to the outside edges of the pole as I roll. At this point, you do not have to roll the fabric tightly, just nice and even and smooth. Roll until the fabric is without much slack between the two poles. Now, from the front of the frame, look at the fabric and readjust the fabric on the front pole if necessary. Sometimes, due to the grainline of the fabric, the fabric will be loose in one area and tighter in another. I simply even the tension by adjusting the tacks on the front pole. After I have adjusted the tension, I add additional tacks to the front pole and then roll the middle pole to adjust to the desired tension. **THE BACK OF THE QUILT IS NOW ON THE FRAME.**

- BATTING:** There are four ways to use the batting so decide now which way you will use.
- #1 Batting is rolled up with the quilt top onto the rear pole.
  - #2 Batting is left hanging free off the middle pole
  - #3 The 4th pole kit is used to roll batting
  - #4 Delicate batting (such as a cotton or wool) rolled similar to method #1

#1 Batting: Place the batting on top of the backing fabric evenly along the front pole and tack to front pole, centering the batting. If you use this method, the quilt top will be needed at this point, as it is rolled with the batting onto the rear pole. Take the quilt top and center it over the center mark of the quilt backing on the front pole. Tack it down, starting in the center and moving outward to the edges. All three layers will now be tacked to the front pole. Tack the other end of the batting and top material to the rear pole. Measure to ensure that all the fabric is centered. Smoothly roll these layers onto the rear pole. Roll until the materials are smoothly and tautly stretched between the poles. Adjust the bottom tension by rolling the middle pole until you get the material to the desired tension. **DO NOT OVER-TIGHTEN.** Apply the wood stop to the cog wheel. Adjust the tension of the top and the batting by rolling the rear pole until you get the layers to the desired tension. **DO NOT OVER-TIGHTEN.** Apply the wood stop to the cog wheel.

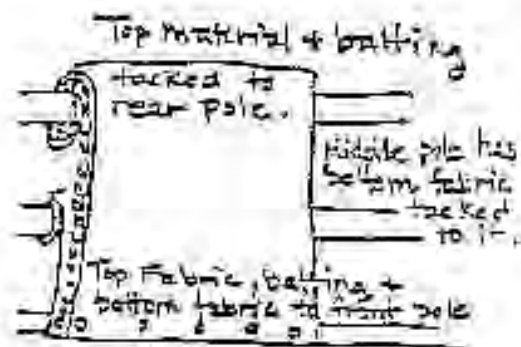
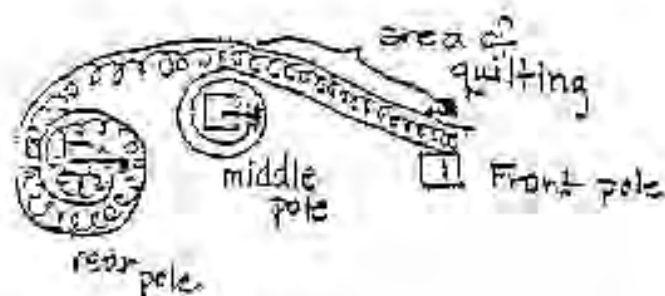

#2 Batting: Bonded batting is recommended for this method. Center the batting on the front pole on top of the quilt backing. Tack down with a few tacks. Smooth the batting over the backing and let it hang free behind the middle pole to the floor. This is a slick, fast method and seems to ensure a smoother roll for me personally than method #1 and is much easier and faster to roll the quilt top onto the frame without the batting being in my way. As you quilt and roll the batting, smooth the batting from underneath at the middle pole with each roll . . . it works great.

#3 Batting using the 4th pole kit: Make sure the 4th pole is properly installed on the frame before proceeding. Center the batting on the front pole on top of the quilt backing and tack down with a few tacks. Smooth the batting out over the backing and over the middle pole and hang down from the middle pole and wrap around the 4th pole. You don't need to tack the batting to the fourth pole, just roll it up carefully. Refer to 4th pole kit instructions.

#4 Delicate Batting Method: Lay the quilt top fabric out wrong side facing up and place the delicate batting on top. Tack these two layers together to the rear pole -- see sketch -- and roll the fabrics onto the rear pole. Next, smooth out the two layers and tack them to the front pole, centering the quilt top to the center of the quilt backing.

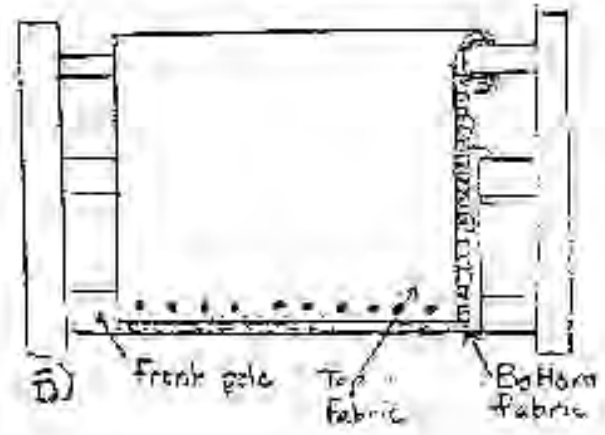

QUILT TOP: If you used method #1, batting roll, you would have rolled the top on with the batting and would now be ready to quilt.

If you used methods 2 or 3, you will now need to attach the quilt top. Fold the quilt top in half and mark the center of the top and bottom edges with pins or pencil mark. Tack the center of the quilt top onto the center mark of the rear pole. Tack corners and smooth out fabric from the center out to the edges and tack down along pole. **DO NOT OVER STRETCH.** Start to roll rear pole. Make sure there are no wrinkles . . . smooth out from center point of pole to outside edges of the pole as you roll. Use the pattern of the fabric, such as a row of blocks, to guide your rolling. Roll until the fabric is almost all on the rear pole. Bring enough of the quilt top to the front pole to tack down. Tack the center mark of the quilt top over the center mark of the quilt backing and tack down along the length of the pole, smoothing from the center out. Do not stretch the fabric as you smooth it out to tack. You may choose to pin the quilt top to the backing at the front rail.

Adjust bottom tension by rolling the middle pole until you get the material to the desired tension. DO NOT OVERTIGHTEN. Apply the wood stop to the cog wheel.

Adjust the top tension by rolling the rear pole until you get the desired tension. DO NOT OVERTIGHTEN. Apply wood stop to cog wheel.

HAPPY QUILTING!

## TROUBLE SHOOTING

**Problem:** Fabric sags on one side or in middle

**Solution:** Fabric may not be square or it may not be cut evenly and straight. Take it off and square it up or pull (gently) to square. Also, refer to untacking along front pole when you put your backing on. If you untack just the front and straighten by retacking, you do not have to take off the entire backing.

**Problem:** Sides of quilt have a concave edge

**Solution:** The fabric was stretched along the pole. Take the the fabric off. Let it relax until it is not misshapen and then re-install, without stretching it along this edge. If quilt is properly installed, side tension will rarely need to be applied. Side tension strips or an Edge Master® may be used to hold side tension but be careful not to pull too tautly.

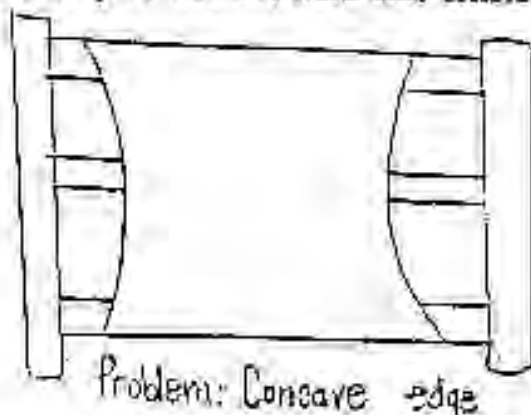

**Problem:** Quilt backing is much longer than quilt top, after quilting

**Solution:** Do not overtighten backing. Regulate tension more closely. Fourth pole kit may help alleviate this problem.

**Problem:** Batting tears or separates during the tightening of the cog wheels.

**Solution:** The batt was too small. By using a few extra inches of batting and letting it sag down a little between the two rear poles, you eliminate this problem. If batting is torn or uneven, you may unroll the rear pole, which holds the batting and top fabric, and fix it at any time during the quilting process. This problem may occur using #1 Batting roll method where top and batting are rolled together. I have never had a batt problem using method # 2 or method # 3 to install batting.

**Problem:** Poles are bowing in.

**Solution:** Causes may be: 1. Seam down the center of the fabrics may be sewn too tightly and is not giving with the rest of the fabric. If the seam is the problem the quilt may be attached sideways. 2. Fabric is not cut evenly. 3. Too much tension has been applied. 4. Fabric has been stretched along the poles instead of smoothly laid along the pole then attached.

**Problem:** Fabric pulls/tears out at the thumbtacks when tension is applied.  
**Solution:** Seat the tack all the way in.. The head should hold the fabric, not the post.  
 Use a tack hammer to seat the tacks.



**Problem:** Poles squeak as they roll or they do not roll freely.  
**Solution:** The frame is not square. Square it up with the floor using a carpenters square or an uncut piece of poster board or a picture frame. If the frame still squeaks after making sure that the frame is in good square alignment, rub some paraffin or candle wax on the dowel ends of the poles.

**Helps for Tied Quilts:**

When rolling into a new area of quilting, allow your last row or ties to remain in the new area of tying. Also, Tie your knots tight. Do not over roll.

\*Note\*-The Edge master is ideal to keep the side of the quilt even and smooth.

Edgemaster™  
 Sold Separately

**EDGEMASTER™**  
iron rolled

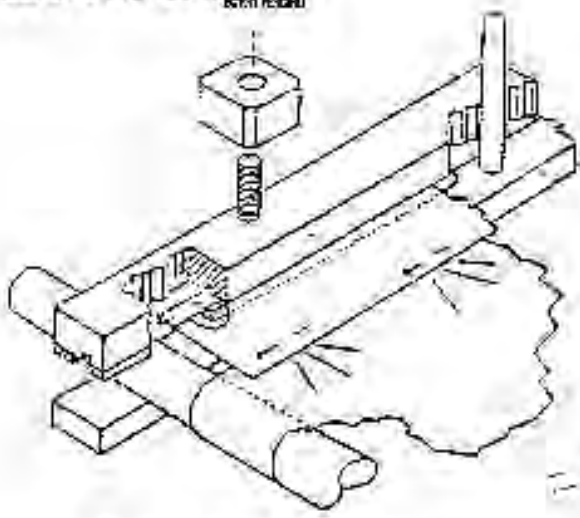

Edgemaster™ keeps the side tension of the quilting fabric even. Loosen wooden nuts to their maximum open position. Separate the two boards of the Edgemaster™ and position them with the quilting frame poles or hoop sides between the two Edgemaster™ boards. Pin quilt edge to muslin strip. Tighten the wooden nut down as you pull gently on the Edgemaster™ to achieve desired side tension. Do not distort fabric by pulling it too tautly.

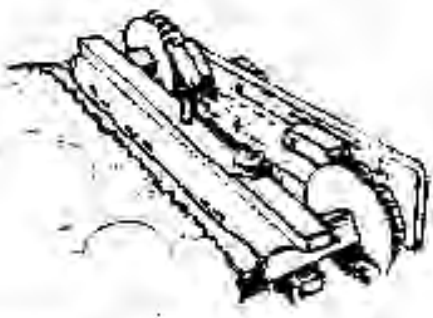

**The Grace Company**  
 P.O. Box 27823  
 Salt Lake City, UT 84127  
 (801) 972-5801



## CLOTH LEADERS

The best cloth selection for making cloth leaders is unbleached muslin or mattress ticking. However, the ticking is a much more expensive selection.

Purchase:

1 1/2 yards	fabric for 58" pole (crib)
2 yards	fabric for 72" pole (twin)
2 2/3 yards	fabric for 94" pole (queen)
3 yards	fabric for 108" pole (king)

### Step 1

Cut the fabric as illustrated:

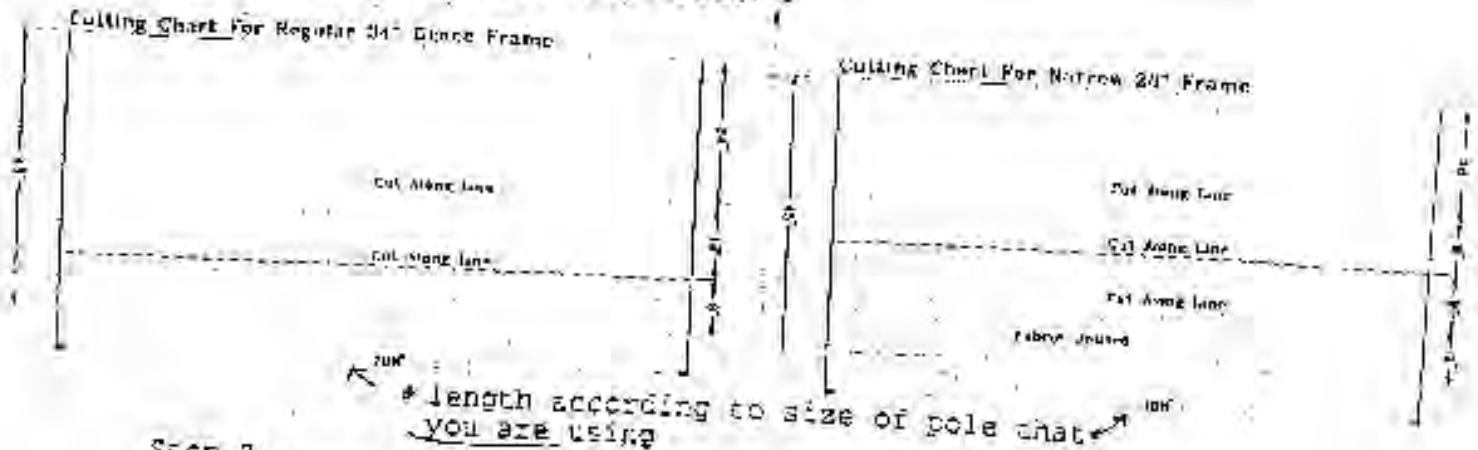

### Step 2

Finish the cut edges of the leaders with either a serger stitch or with a very straight 1/2" hem allowance. Press the leader cloth with a warm iron. Draw a straight, dark, solid line 1" from one edge of each of the leader cloths.

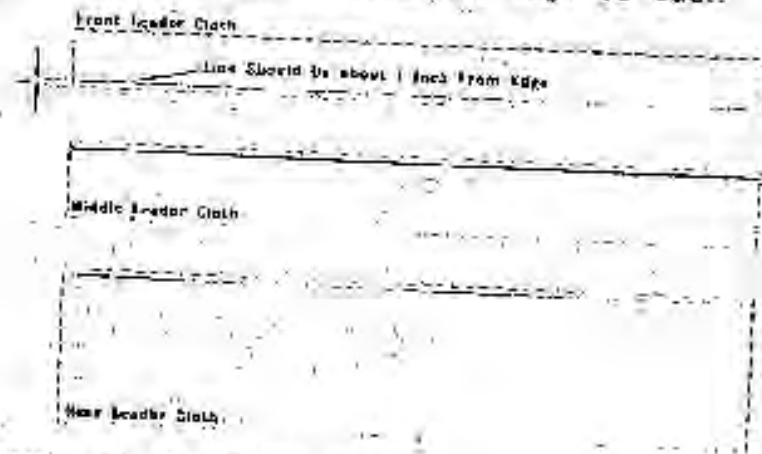

### Step 3

Thumb tack 9" width strip on the front pole

Thumb tack 12" width strip on the middle pole

Thumb tack 24" width strip on back pole

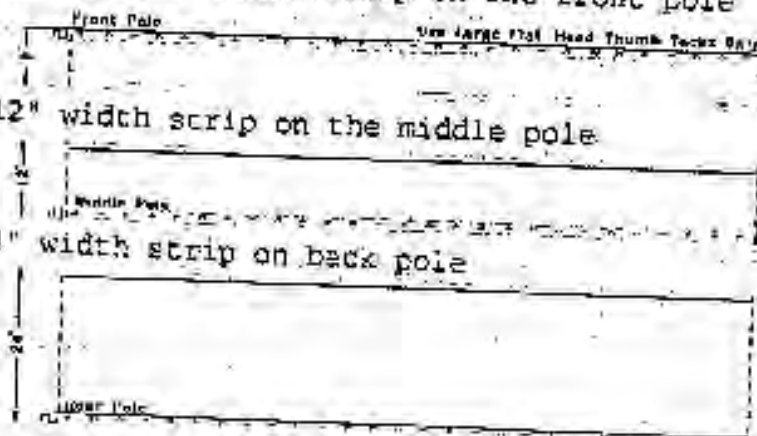

#### Step 4

Pin or baste your bottom fabric to the front pole cloth leader. Use the dark, straight, solid line that you marked on your cloth leader in step 2 to align with the edge of your material.

Pin or baste your bottom fabric to the middle pole cloth leader. Use the solid line again to align with the edge of your quilt material.

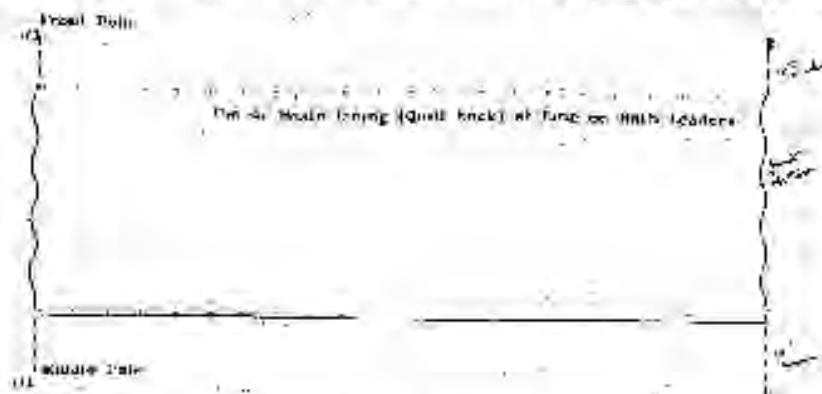

Roll the backing fabric up onto the middle pole using the cog wheel. Keep the fabric smooth and even as you roll. Continue rolling until you have a smooth and even tension on the fabric.

#### Step 5

Pin or baste the batting to the front pole cloth leader. Use the solid line to align with the edge of your batting.

Select one of the following alternatives to applying batting:

1. Pin or baste the batting to the rear pole cloth leader.
2. Drop the batting to the floor between the middle and rear poles.
3. Apply the batting to the 4th pole kit.

#### Step 6

Pin or baste the quilt top to the front pole cloth leader. (The front pole cloth leader has the back material, the batting and the quilt top all attached to it.)

Use the solid line that is on your cloth leader to align with the edge of your quilt top as you baste your quilt.

Pin or baste the opposite end of your quilt top to the rear pole cloth leader. Use the dark, straight line to align with the edge of your quilt top.

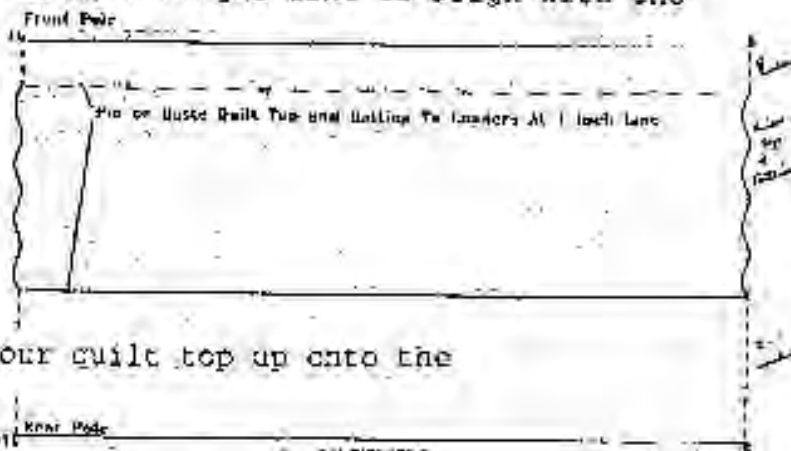

#### Step 7

Using the rear cog wheel roll your quilt top up onto the rear pole.

#### Step 8

You are now ready to quilt.